



# CHADHA POWER



**TECHNICAL DATA SHEET FOR EP 100-12 (12V 100AH)  
AGM VRLA SEALED MAINTENANCE FREE BATTERY**

# BATTERY OUTLINE & DIMENSIONS

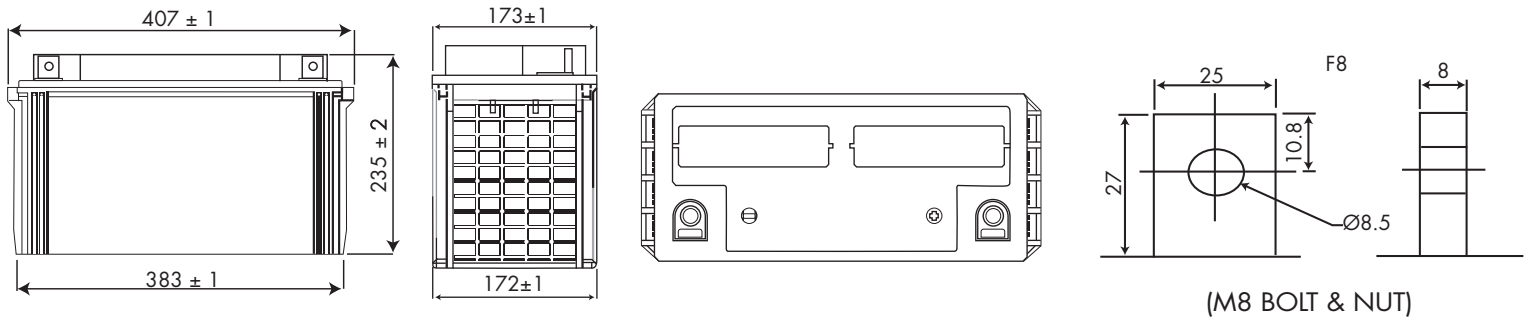

# CONSTRUCTION

- Positive and negative plates in lead-tin-calcium alloy
- Separator - low resistance micro porous glass fiber. The electrolyte is absorbed within this material, preventing acid leakage in case of accidental damage
- Terminals with a large surface area to provide maximum conductivity
- Self-regulating pressure relief valve
- 100% ensured capacity (through data-logger) during manufacturing
- Stronger, sturdier & attractive packaging
- Specially suited for UPS & Power Application

# FEATURES

- International Size
- Eco-Friendly
- Ready to Use
- Low Self-discharge
- Superior High Rate Discharge
- Performance Characteristics conforming to JISC8702
- Free from Orientation Constraints
- Easy Handling
- Long Service Life
- Excellent Charge retention & recovering ability
- High Reliability

# SPECIFICATION CHART

Battery Type	Nominal Voltage (V)	Rated Capacity (Ah) at 27°C						Dimensions (mm)				Weight (Kg) (±5%)
		20 hr 1.75V/ cell	10 hr 1.75V/ cell	3 hr 1.7V/ cell	1.5 hr 1.7V/ cell	1 hr 1.6V/ cell	30 mins 1.6V/ cell	Overall Height ±2	Height up to lid top ±2	Length ±1	Width ±1	
EP100-12	12	100.0	91.0	75.0	72.0	60.0	50.0	235.0	235.0	407.0	173.0	32.5

## NOTES ON OPERATION

Mode of Operation	Voltage setting per 12V unit for ambient Temp. 20-30°C	Current setting
FLOAT	13.7V +/-0.1V	Maximum: 0.3CA Minimum: 0.1CA
BOOST	14.1V +/-0.1V	
CYCLE	14.7V +/-0.1V	

## CONSTANT POWER DISCHARGE RATING IN WATTS PER BATTERY FOR EP RANGE AT 27°C

	AH	5 min	10 min	15 min	20 min	30 min	60 min
Watt/Battery at 1.60V	100AH	3834	2569	2015	1618	1207	749
Watt/Battery at 1.70V		3660	2416	1948	1583	1200	724
Watt/Battery at 1.80V		3307	2323	1810	1491	1125	682

## DISCHARGE CURRENT & RECOMMENDED FINAL DISCHARGE VOLTAGE

Discharge Current (A)	Final Discharge Voltage (V/Cell)
0.2 C > (A) or intermittent discharge	1.75
0.2 C < or = (A) < 0.5 C	1.70
0.5 C < or = (A) < 1.0 C	1.55
1.0 C < or = (A)	1.30

## CHARACTERISTIC CURVES

### SERVICE LIFE

#### CYCLIC USE

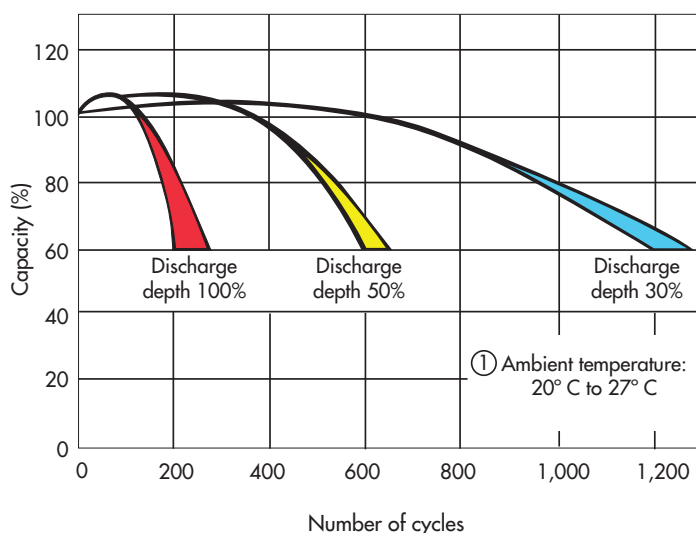

#### STANDBY USE

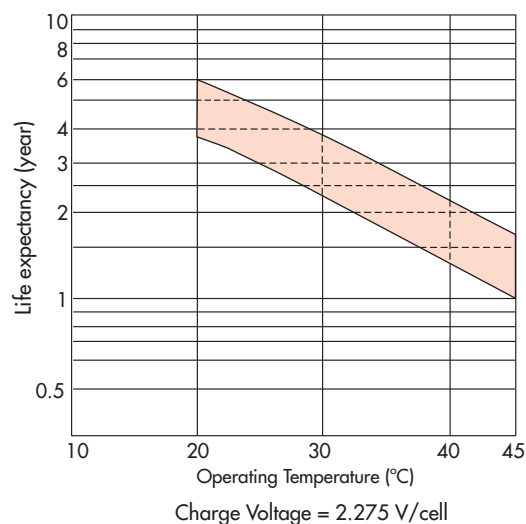

# CHARGE CHARACTERISTICS

## CYCLIC USE

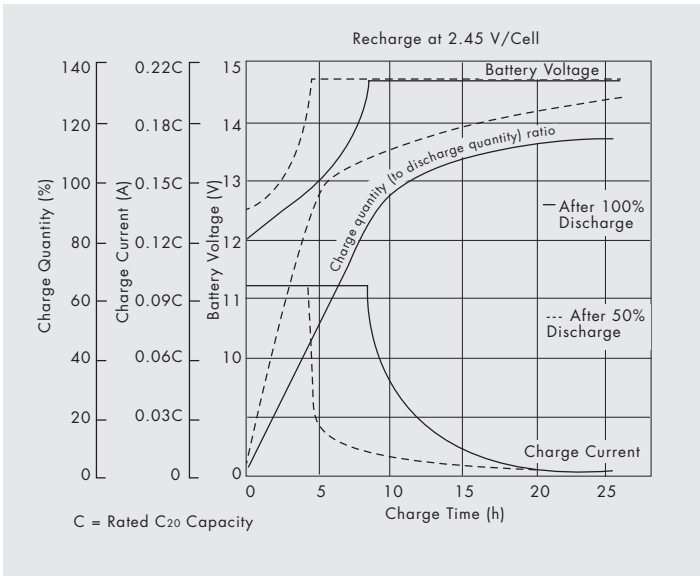

## STANDBY USE

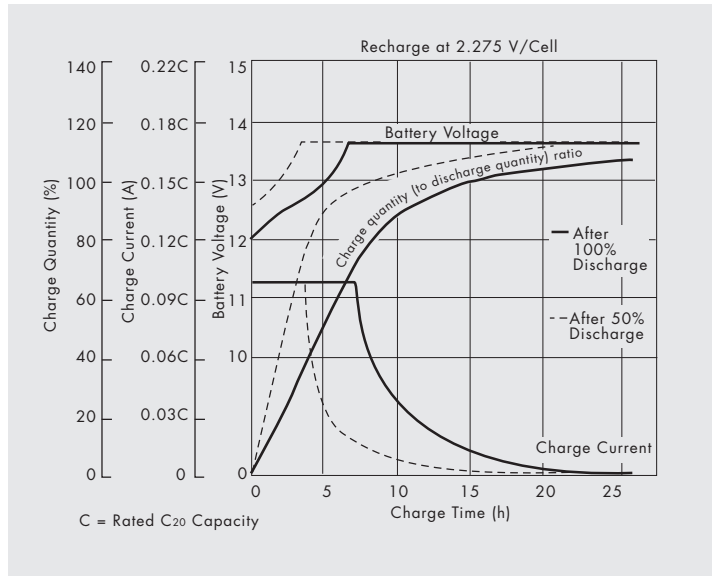

# OTHER CURVES

## DISCHARGE CHARACTERISTICS

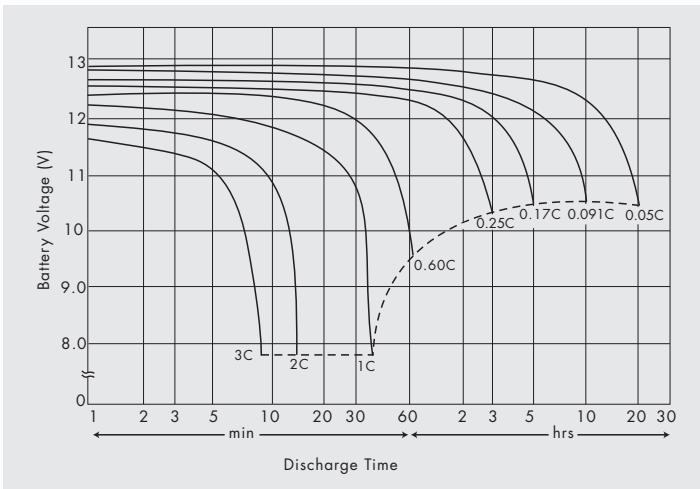

## EFFECT OF TEMPERATURE ON CAPACITY

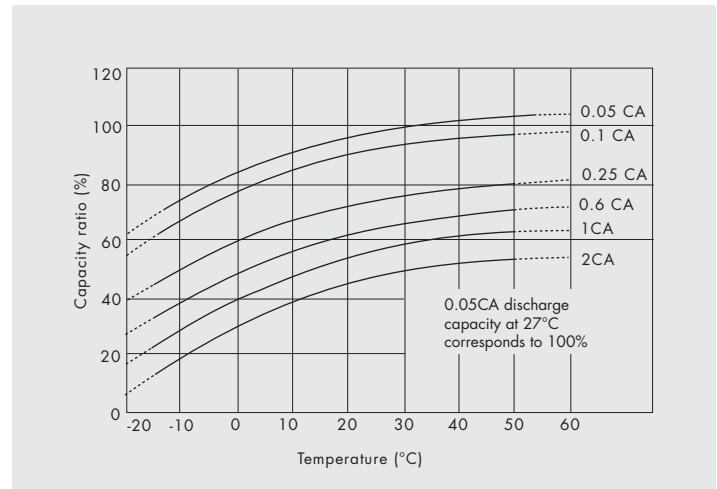

## CAPACITY RETENTION

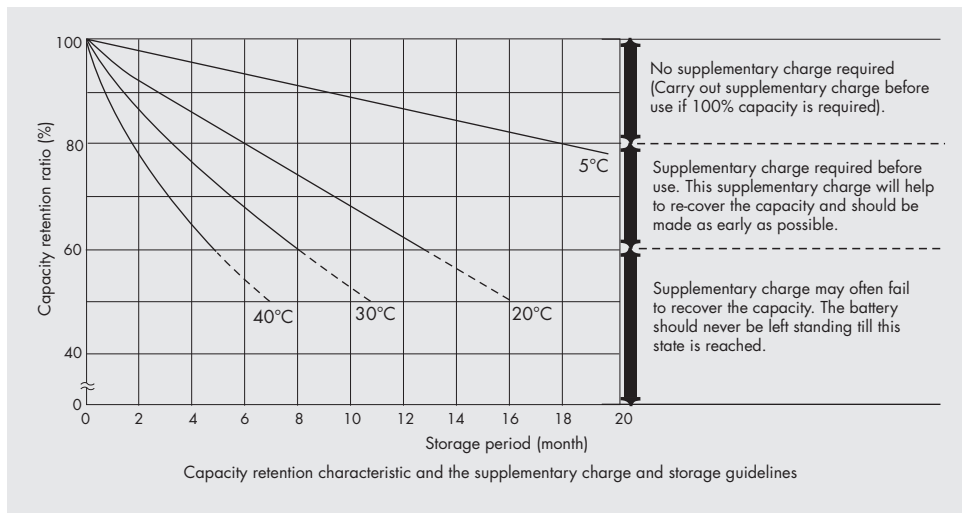

## PRODUCT DETAILS

AH Efficiency	>90%
WH Efficiency	>80%
Internal Resistance	6 mΩ max at full charge 27°C
Short Circuit Current	2151 Amps
Operating Temperature Range	0°C to 45°C
Self Discharge/Month at 27°C	<3% of Rated Capacity
Material of container	PPCP
Type of +ve & -ve plate	Flat Pasted
Recommended Terminal Torque	12.3 N-m

## MAXIMUM DISCHARGE CURRENT FOR VARIOUS DURATION & CUT-OFF VOLTAGE

END VOLTAGE / CELL	TEMP (C)	DISCHARGE TIME												
		10min	15min	20min	30min	1 hr	1.5 hrs	2 hrs	3 hrs	4 hrs	5 hrs	6 hrs	8 hrs	10 hrs
1.80	25	2.0C	1.65C	1.4C	1.1C	0.64C	0.42C	0.36C	0.27C	0.210C	0.17C	0.145C	0.11C	0.090C
	5	1.65C	1.3C	1.1C	0.95C	0.59C	0.34C	0.29C	0.230C	0.182C	0.147C	0.129C	0.098C	0.080C
	-5	1.3C	1.0C	0.86C	0.76C	0.48C	0.28C	0.24C	0.198C	0.154C	0.125C	0.115C	0.087C	0.071C
1.75	25	2.15C	1.72C	1.45C	1.12C	0.65C	0.45C	0.38C	0.28C	0.22C	0.180C	0.15C	0.12C	0.099C
	5	1.72C	1.40C	1.15C	0.97C	0.60C	0.36C	0.30C	0.24C	0.190C	0.150C	0.130C	0.100C	0.088C
	-5	1.45C	1.10C	0.93C	0.81C	0.50C	0.30C	0.25C	0.20C	0.160C	0.130C	0.119C	0.090C	0.078C
1.70	25	2.3C	1.8C	1.5C	1.15C	0.67C	0.48C	0.40C	0.29C	0.230C	0.19C	0.165C	0.13C	0.108C
	5	1.8C	1.5C	1.2C	1.0C	0.62C	0.39C	0.32C	0.250C	0.199C	0.164C	0.143C	0.116C	0.096C
	-5	1.6C	1.2C	1.0C	0.86C	0.53C	0.32C	0.27C	0.213C	0.168C	0.139C	0.123C	0.103C	0.086C
1.65	25	2.35C	1.85C	1.55C	1.2C	0.69C	0.50C	0.41C	0.300C	0.240C	0.200C	0.170C	0.135C	0.110C
	5	1.9C	1.6C	1.3C	1.05C	0.64C	0.40C	0.33C	0.260C	0.208C	0.173C	0.147C	0.120C	0.098C
	-5	1.6C	1.25C	1.05C	0.88C	0.54C	0.34C	0.27C	0.220C	0.176C	0.147C	0.125C	0.107C	0.087C
1.60	25	2.4C	1.9C	1.6C	1.25C	0.7C	0.51C	0.42C	0.310C	0.250C	0.210C	0.180C	0.140C	0.115C
	5	2.0C	1.7C	1.4C	1.10C	0.66C	0.41C	0.34C	0.270C	0.216C	0.182C	0.156C	0.125C	0.102C
	-5	1.65C	1.3C	1.1C	0.9C	0.55C	0.34C	0.28C	0.227C	0.183C	0.154C	0.132C	0.111C	0.091C

\*Note: C represents the C20 rated capacity.

Technical specifications are subject to change without prior notice.  
Battery image shown is indicative and may vary from the actual.



### CHADHA POWER

#### INDIA

**CHADHA POWER LLP**  
F-Block, Ground Floor  
The Mira Corporate Suites  
1 & 2, Old Ishwar Nagar, Mathura Road  
New Delhi – 110065, India  
Tel: + 91 11 26910057

Website: [www.chadhapower.com](http://www.chadhapower.com)  
Email: [sales@chadhapower.com](mailto:sales@chadhapower.com)

#### SOUTH AFRICA

**CHADHA POWER (SA) (PTY) LTD**  
Unit 30, Bridgeway Business Park  
496 Pinnacle Street, Tunney  
Germiston, 1401  
South Africa  
Tel: +27 11 708 0001

Website: [www.chadhapower.co.za](http://www.chadhapower.co.za)  
Email: [salessa@chadhapower.com](mailto:salessa@chadhapower.com)