



CHADHA POWER



**TECHNICAL DATA SHEET FOR EP 100-12 (12V 100AH)
AGM VRLA SEALED MAINTENANCE FREE BATTERY**

BATTERY OUTLINE & DIMENSIONS

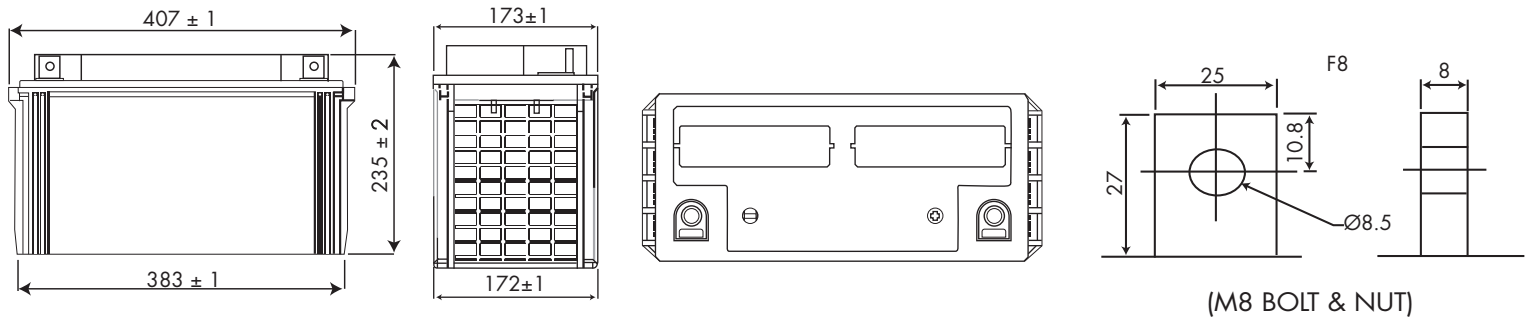

CONSTRUCTION

- Positive and negative plates in lead-tin-calcium alloy
- Separator - low resistance micro porous glass fiber. The electrolyte is absorbed within this material, preventing acid leakage in case of accidental damage
- Terminals with a large surface area to provide maximum conductivity
- Self-regulating pressure relief valve
- 100% ensured capacity (through data-logger) during manufacturing
- Stronger, sturdier & attractive packaging
- Specially suited for UPS & Power Application

FEATURES

- International Size
- Eco-Friendly
- Ready to Use
- Low Self-discharge
- Superior High Rate Discharge
- Performance Characteristics conforming to JISC8702
- Free from Orientation Constraints
- Easy Handling
- Long Service Life
- Excellent Charge retention & recovering ability
- High Reliability

SPECIFICATION CHART

Battery Type	Nominal Voltage (V)	Rated Capacity (Ah) at 27°C						Dimensions (mm)				Weight (Kg) (±5%)
		20 hr 1.75V/ cell	10 hr 1.75V/ cell	3 hr 1.7V/ cell	1.5 hr 1.7V/ cell	1 hr 1.6V/ cell	30 mins 1.6V/ cell	Overall Height ±2	Height up to lid top ±2	Length ±1	Width ±1	
EP100-12	12	100.0	91.0	75.0	72.0	60.0	50.0	235.0	235.0	407.0	173.0	32.5

NOTES ON OPERATION

Mode of Operation	Voltage setting per 12V unit for ambient Temp. 20-30°C	Current setting
FLOAT	13.7V +/-0.1V	Maximum: 0.3CA Minimum: 0.1CA
BOOST	14.1V +/-0.1V	
CYCLE	14.7V +/-0.1V	

CONSTANT POWER DISCHARGE RATING IN WATTS PER BATTERY FOR EP RANGE AT 27°C

	AH	5 min	10 min	15 min	20 min	30 min	60 min
Watt/Battery at 1.60V	100AH	3834	2569	2015	1618	1207	749
Watt/Battery at 1.70V		3660	2416	1948	1583	1200	724
Watt/Battery at 1.80V		3307	2323	1810	1491	1125	682

DISCHARGE CURRENT & RECOMMENDED FINAL DISCHARGE VOLTAGE

Discharge Current (A)	Final Discharge Voltage (V/Cell)
0.2 C > (A) or intermittent discharge	1.75
0.2 C < or = (A) < 0.5 C	1.70
0.5 C < or = (A) < 1.0 C	1.55
1.0 C < or = (A)	1.30

CHARACTERISTIC CURVES

SERVICE LIFE

CYCLIC USE

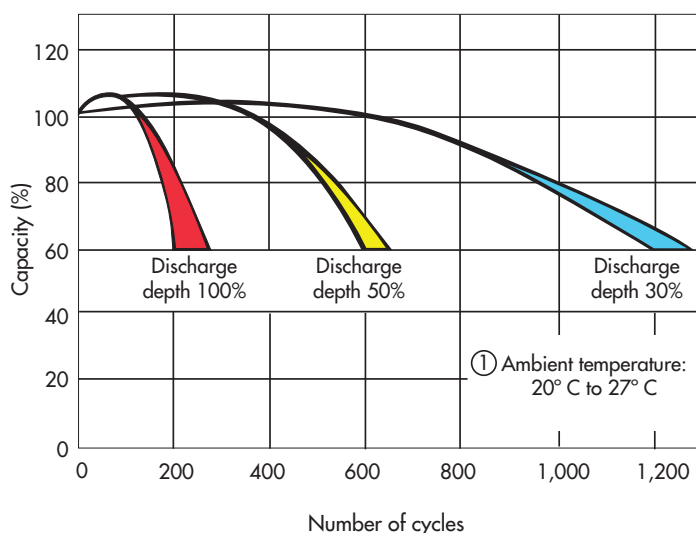

STANDBY USE

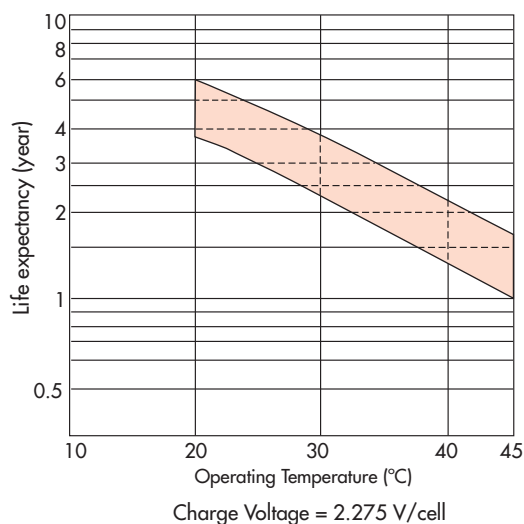

CHARGE CHARACTERISTICS

CYCLIC USE

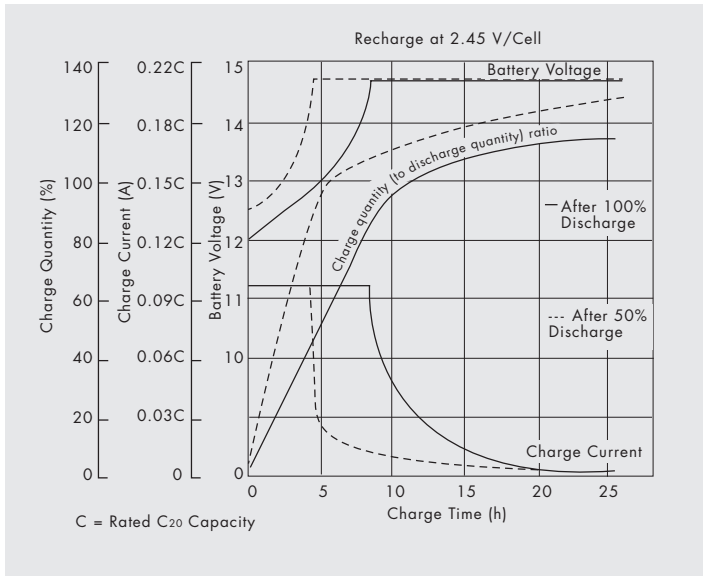

STANDBY USE

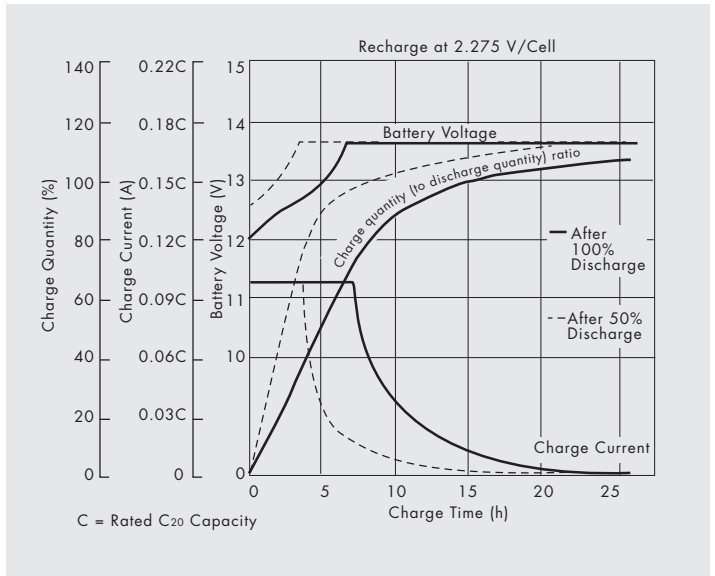

OTHER CURVES

DISCHARGE CHARACTERISTICS

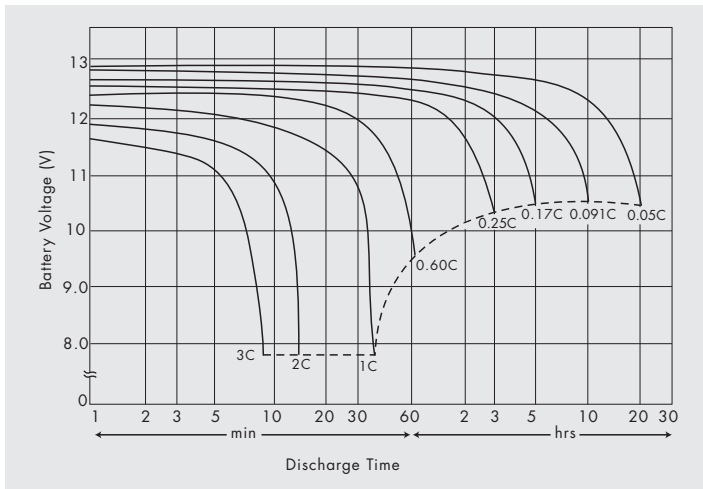

EFFECT OF TEMPERATURE ON CAPACITY

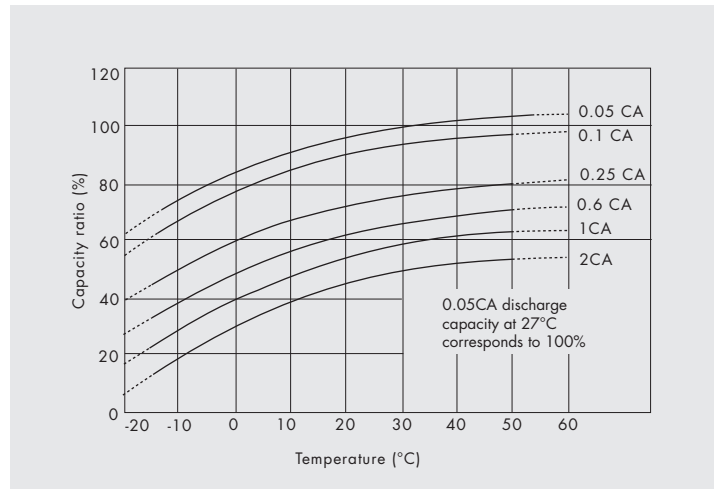

CAPACITY RETENTION

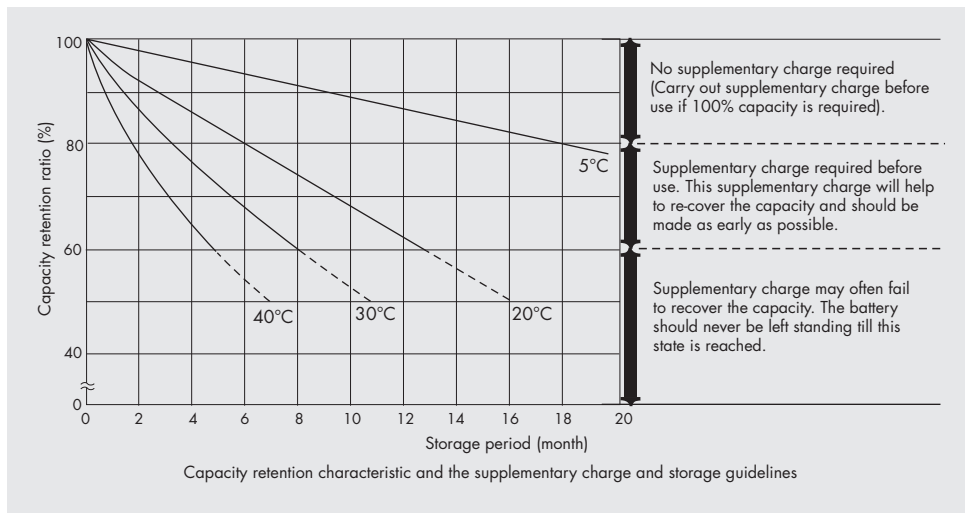

PRODUCT DETAILS

AH Efficiency	>90%
WH Efficiency	>80%
Internal Resistance	6 mΩ max at full charge 27°C
Short Circuit Current	2151 Amps
Operating Temperature Range	0°C to 45°C
Self Discharge/Month at 27°C	<3% of Rated Capacity
Material of container	PPCP
Type of +ve & -ve plate	Flat Pasted
Recommended Terminal Torque	12.3 N-m

MAXIMUM DISCHARGE CURRENT FOR VARIOUS DURATION & CUT-OFF VOLTAGE

END VOLTAGE / CELL	TEMP (C)	DISCHARGE TIME												
		10min	15min	20min	30min	1 hr	1.5 hrs	2 hrs	3 hrs	4 hrs	5 hrs	6 hrs	8 hrs	10 hrs
1.80	25	2.0C	1.65C	1.4C	1.1C	0.64C	0.42C	0.36C	0.27C	0.210C	0.17C	0.145C	0.11C	0.090C
	5	1.65C	1.3C	1.1C	0.95C	0.59C	0.34C	0.29C	0.230C	0.182C	0.147C	0.129C	0.098C	0.080C
	-5	1.3C	1.0C	0.86C	0.76C	0.48C	0.28C	0.24C	0.198C	0.154C	0.125C	0.115C	0.087C	0.071C
1.75	25	2.15C	1.72C	1.45C	1.12C	0.65C	0.45C	0.38C	0.28C	0.22C	0.180C	0.15C	0.12C	0.099C
	5	1.72C	1.40C	1.15C	0.97C	0.60C	0.36C	0.30C	0.24C	0.190C	0.150C	0.130C	0.100C	0.088C
	-5	1.45C	1.10C	0.93C	0.81C	0.50C	0.30C	0.25C	0.20C	0.160C	0.130C	0.119C	0.090C	0.078C
1.70	25	2.3C	1.8C	1.5C	1.15C	0.67C	0.48C	0.40C	0.29C	0.230C	0.19C	0.165C	0.13C	0.108C
	5	1.8C	1.5C	1.2C	1.0C	0.62C	0.39C	0.32C	0.250C	0.199C	0.164C	0.143C	0.116C	0.096C
	-5	1.6C	1.2C	1.0C	0.86C	0.53C	0.32C	0.27C	0.213C	0.168C	0.139C	0.123C	0.103C	0.086C
1.65	25	2.35C	1.85C	1.55C	1.2C	0.69C	0.50C	0.41C	0.300C	0.240C	0.200C	0.170C	0.135C	0.110C
	5	1.9C	1.6C	1.3C	1.05C	0.64C	0.40C	0.33C	0.260C	0.208C	0.173C	0.147C	0.120C	0.098C
	-5	1.6C	1.25C	1.05C	0.88C	0.54C	0.34C	0.27C	0.220C	0.176C	0.147C	0.125C	0.107C	0.087C
1.60	25	2.4C	1.9C	1.6C	1.25C	0.7C	0.51C	0.42C	0.310C	0.250C	0.210C	0.180C	0.140C	0.115C
	5	2.0C	1.7C	1.4C	1.10C	0.66C	0.41C	0.34C	0.270C	0.216C	0.182C	0.156C	0.125C	0.102C
	-5	1.65C	1.3C	1.1C	0.9C	0.55C	0.34C	0.28C	0.227C	0.183C	0.154C	0.132C	0.111C	0.091C

*Note: C represents the C20 rated capacity.

Technical specifications are subject to change without prior notice.
Battery image shown is indicative and may vary from the actual.



CHADHA POWER

INDIA

CHADHA POWER LLP
F-Block, Ground Floor
The Mira Corporate Suites
1 & 2, Old Ishwar Nagar, Mathura Road
New Delhi – 110065, India
Tel: + 91 11 26910057

Website: www.chadhapower.com
Email: sales@chadhapower.com

SOUTH AFRICA

CHADHA POWER (SA) (PTY) LTD
Unit 1, Oakhurst Office Park
112 Ridge Road
Bartlett, Boksburg, 1459
South Africa
Tel: +27 11 708 0001

Website: www.chadhapower.co.za
Email: salessa@chadhapower.com